

# ROSCO

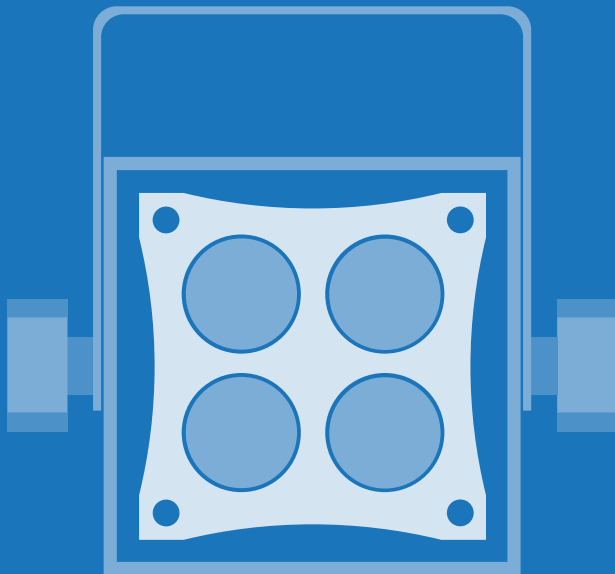

**MIRO CUBE<sup>®</sup>**  
DESIGNED BY THE BLACK TANK

USER'S MANUAL



# Table of Contents

## **Your Miro Cube**

Product Description.....	5
What's In the Box.....	7
Miro Cube Interface.....	8

## **Miro Cube Series**

Miro Cube 4C & 4CA.....	10
Miro Cube WNC/3W.....	12
Miro Cube UV365.....	13

## **Miro Cube Modes**

DMX Mode.....	14
Manual Mode.....	20
Color Wash Mode .....	24
Serial Mode .....	27

## **Beam Angles**

Spread Lens.....	28
Changing the Spread Lens.....	29

## **Mounting and Configuration**

Linear Array.....	30
Safety Cables.....	32

## **Miro Cube Support**

FCC Warning.....	33
General Precautions.....	34
Warning Messages.....	35

## Product Description

### **Miro Cube®**

Rosco's innovative Miro Cube series of LED wash lights packs 50 watts outputting more than 3400 lumens into a compact and portable 4 inch cube! The sleek yet rugged, geometric design of the Miro Cube is perfectly at home in museums, on track light systems, in stores and lobbies or built into sets, truss and lighting rigs of all styles.

These luminaires offer the flexibility and versatility needed for any type of lighting challenge. No expensive external power supply or ballast is required, the Miro Cube plugs directly into the wall anywhere in the world, automatically adjusting to mains power from 90-240vAC 50-60hz. Drawing less than 1 amp of current, more than 40 Miro Cubes can be plugged into a single 20A circuit!

An intuitive LCD control panel sets virtually every aspect of the lights including a master-slave configuration for fast lighting set-ups. Completely flicker free dimming is available via DMX (in 8 or 16 bit resolution).

## Product Description

Mounting these compact 4 inch cubes is limited only by the imagination of the installer. The novel through bolted yoke design allows units to be easily ganged into multi-unit strips and arrays for greater output and coverage. Weighing just 2-1/2 pounds, the Miro Cube can be attached to standard architectural lighting track using accessory track adapters. For the easiest track installation, use our DMX track and pass DMX to all the luminaires on the track without cable jumpers.

Available in versions that offer full color mixing, tunable color temperature white light, or high powered ultra-violet light for stunning black-light effects, the Miro Cube luminaires are the smallest, most feature packed and affordable, professional grade LED wash lights on the market.

## What's In the Box

**[1]** Miro Cube

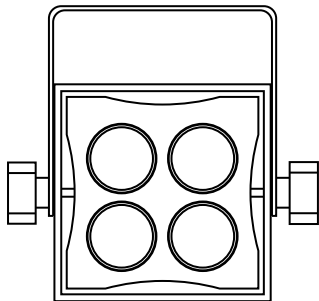

**[2]** Power Cable

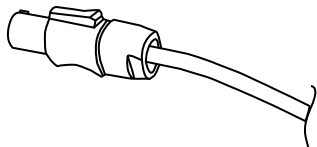

**[3]** Set of Symmetrical Spread Lenses

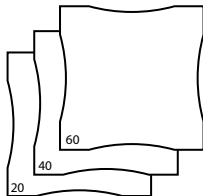

## Miro Cube Interface

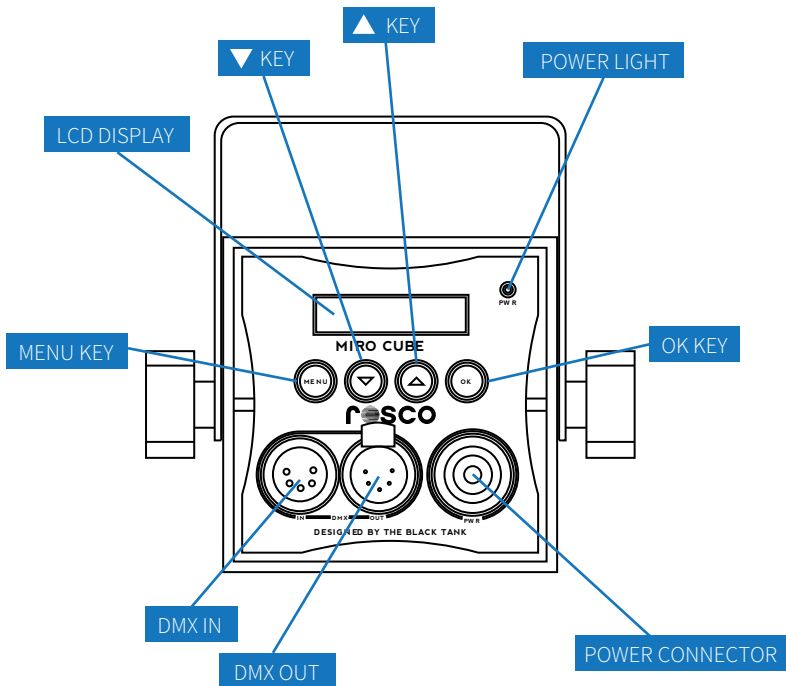



# Miro Cube Interface

## ARC Version

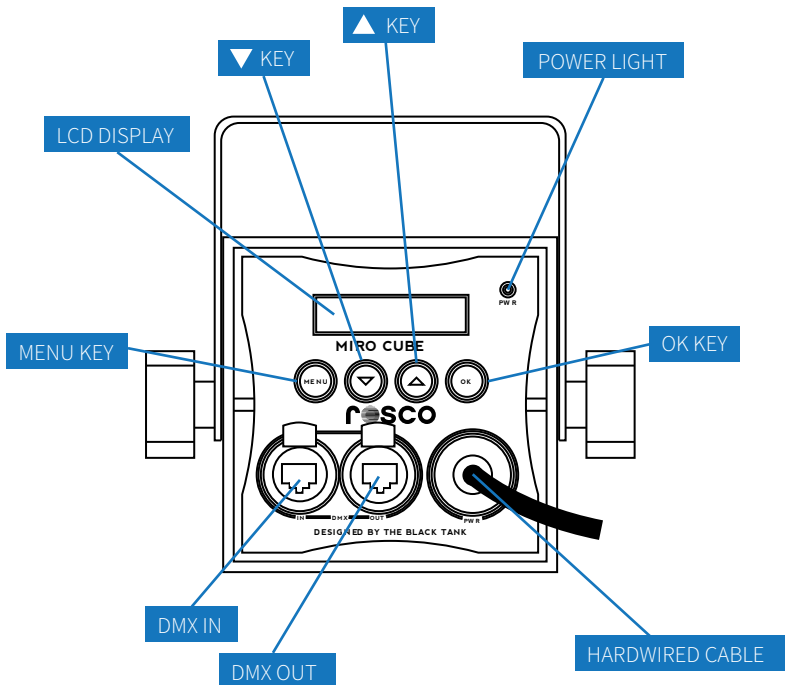

## Miro Cube 4C & 4CA

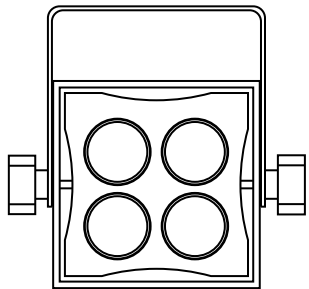

From walls to washes to uplighters, the Miro Cube 4C & 4CA color mixing wash light offers a designer maximum creativity in a tiny package. The best-in-class quad-chip emitters inside the Miro Cube RGBW 4C and the RGBA 4CA produce a gorgeous palette of saturated, mid-tone and pale tint colors. The 4C and 4CA can also mix an attractive, full spectrum white light in warm and cool color temperatures - not the unflattering compromise found in other color-mixing LED lights.

The Miro Cube 4CA features a unique, phosphor-converted amber emitter – not found in any other RGBA fixture this size. This enables it to produce an expanded palette of saturated colors and rich, warm-tones of full-spectrum white light.

Smart programming in the Miro Cube 4C & 4CA includes a

stand-alone color wash mode or allows multiple units to be easily slaved together, synchronized and offset using self-generated DMX for color chases and other dynamic lighting patterns without a console. Use it alone, configured in strips & arrays or built-in for virtually any application needing colored light - from stage, studios and location, bars and casinos, to stores, windows and lobbies.

**NOTE:** The luminaire should be positioned so that prolonged staring into the luminaire at a distance closer than 3.3m is not expected.

## Miro Cube WNC/3W

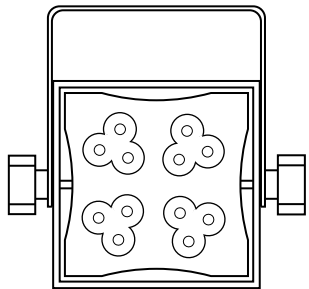

Size matters. But quality of light matters more! The Miro Cube WNC/3W embodies what every lighting professional needs - a bright, tunable, beautiful white light. Using 12 high quality Cree XML 4W emitters, the Miro WNC outputs 3400 lumens and can adjust from 2700K to 6500K. A mix of warm, neutral and cool LEDs insure excellent rendering across all color temperatures making it perfect for use on TV or film sets, in retail lighting, museums, architecture, photography studios or any white light application.

A 3W option provides a fixed 2700K color temperature popular with many hospitality venues.

**NOTE:** The luminaire should be positioned so that prolonged staring into the luminaire at a distance closer than 0.31m is not expected.

## Miro Cube UV365

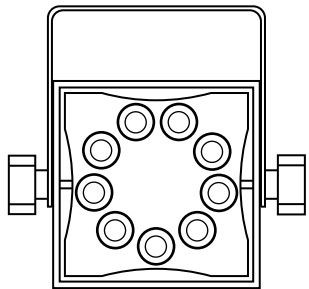

Ideally suited for theme parks, night clubs, casinos, museums and stage applications, Miro Cube UV365 is the smallest, most affordable high powered UV light available to lighting professionals. Drawing just 50 watts, it outperforms conventional long throw fixtures using 5 times the power, weighing 10 times more, and which need an expensive lamp change every 1000 hours! The fixture allows for full speed 8 and 16 bit DMX dimming and standalone control (without a DMX source) via a rear mounted full text LCD display.

**WARNING:** Do not look directly into the UV light during operation. Eye and skin exposure to UV light can cause severe damage to humans and animals. Take every precaution to limit exposure to UV light (including the use of UV-blocking eye protection).



## DMX Mode

In DMX mode, the unit is controlled by the data it receives on the 5-pin XLR or RJ45 (ARC) connectors located on the rear panel. The number of DMX channels required to control the fixture is dependent on the factory setting in use. See pg. 19 for Miro Cube DMX channels.

**NOTE:** A three pin to five pin XLR adapter may be used with the fixture

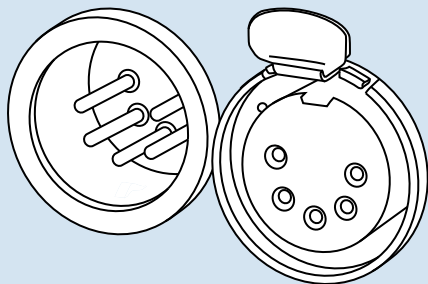

**5-pin XLR Connectors**

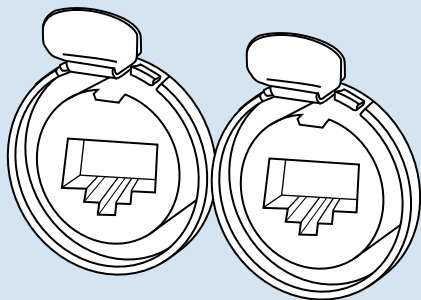

**RJ45 Connectors**



## DMX Mode

There are four user settings that can be adjusted in DMX mode. The current value of each setting is shown on the main screen.

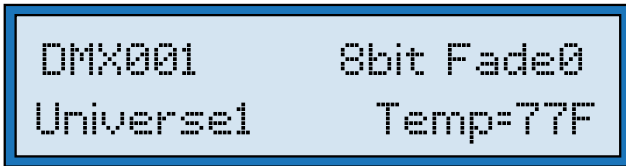

### DMX Address:

To change the DMX address, press **MENU** until “**CHANGE DMX ADDRESS?**” appears on the LCD, and press **OK**. Select the desired DMX address using the **▲** or **▼** keys, and press **OK**.



## DMX Mode

### Universe1 or Universe2

The Miro Cube can be controlled via two unique DMX universes. DMX can be input on pins 2&3 (Universe1) or pins 4&5 (Universe2) via the 5 pin XLR connectors on the rear panel. This allows two complete universes of DMX to be transmitted on a single cable.

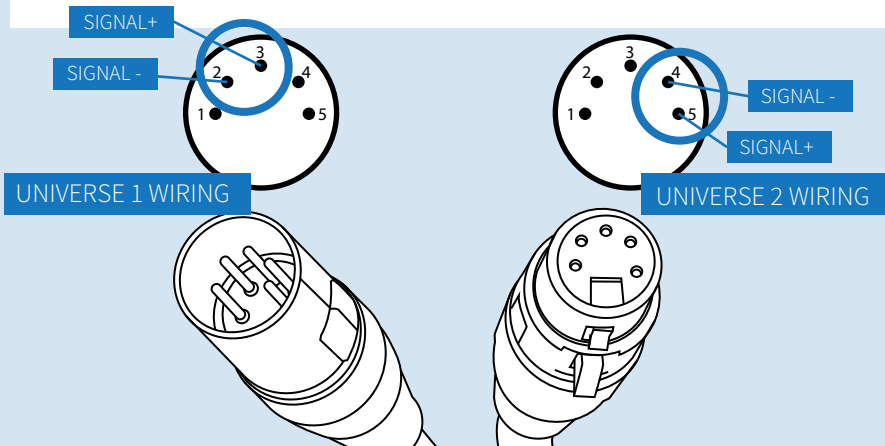

To change from Universe1 to Universe2 (or from Universe2 to Universe1) press **MENU** until “**SET TO UNIVERSE 2?**” or “**SET TO UNIVERSE 1?**” appears on the LCD, then press **OK**



















## DMX Mode

### Universe1 or Universe2 (ARC):

The Miro Cube can be controlled via two unique DMX universes. DMX can be input on pins 1&2 (Universe1) or pins 3&6 (Universe2) via the RJ45 connectors on the rear panel. This allows two complete universes of DMX to be transmitted on a single cable.

PIN	1	2	3	4	5	6	7	8
T568A Color								
	White /Green	Green	White /Orange	Blue	White /Blue	Orange	White /Brown	Brown
T568B Color								
	White /Orange	Orange	White /Green	Blue	White /Blue	Green	White /Brown	Brown

To change from Universe1 to Universe2 (or from Universe2 to Universe1) press **MENU** until **“SET TO UNIVERSE 2?”** or **“SET TO UNIVERSE 1?”** appears on the LCD, then press **OK**



## DMX Mode

### 8 bit or 16 bit DMX:

The fixture can run in either 8 bit or 16 bit DMX mode. In 8 bit mode, the Miro Cube accepts one DMX channel for each color. In 16 bit mode, two channels are required for each color. To change from 8 bit to 16 bit mode (or from 16 bit to 8 bit) press **MENU** until “**SET TO 16BIT DMX?**” or “**SET TO 8BIT DMX?**” appears on the LCD, then press **OK**.

### Filament Fade:

An incandescent lamp has a slight delay, or lag with changing intensities, whereas an LED responds instantly. The difference is most noticeable during a theatrical black out. The Miro Cube can emulate an incandescent lamp by selecting one of the Tungsten Fade settings.

To change the Tungsten Fade setting, press **MENU** until “**CHANGE FILAMNT FADE?**” appears on the screen, and press **OK**. Select from “**OFF**”, “**1 (MIN)**”, “**2 (MID)**” or “**3 (MAX)**” using the **▲** or **▼** keys, and press **OK**. A setting of “**3 (MAX)**” provides the greatest delay. A setting of “0” will turn the Filament Fade off, and allow the LEDs to respond instantly to changing DMX input.



### DMX Channel Layout:

#### 8 BIT MODE:

##### 4C & 4CA

- 1 - Red
- 2 - Green
- 3 - Blue
- 4 - White/Amber

##### WNC

- 1 - Warm
- 2 - Neutral
- 3 - Cool

##### 3W

- 1 - All Warm LEDs

##### UV

- 1 - All UV LEDs

#### 16 BIT MODE:

##### 4C & 4CA

- 1 - Red Coarse
- 2 - Red Fine
- 3 - Green Coarse
- 4 - Green Fine
- 5 - Blue Coarse
- 6 - Blue Fine
- 7 - White/Amber Coarse
- 8 - White Fine

##### WNC

- 1 - Warm Coarse
- 2 - Warm Fine
- 3 - Neutral Coarse
- 4 - Neutral Fine
- 5 - Cool Coarse
- 6 - Cool Fine

##### 3W

- 1 - All Warm LEDs Coarse
- 2 - All Warm LEDs Fine

##### UV

- 1 - All UV LEDs Coarse
- 2 - All UV LEDs Fine



## Manual Mode

**WARNING:** DO NOT CONNECT ANY MIRO CUBE IN MANUAL MODE TO ANY OTHER DMX SENDING DEVICE AS CONTENTION ON THE DMX512 INPUT WILL RESULT.

In Manual Mode, the Miro Cube can be controlled directly from its rear panel without the need of a DMX console or a DMX control device. Standalone control capabilities vary according to the factory setting in use (Four Color, Three Color, or One Color). Factory settings are password protected but can be adjusted. Contact the manufacturer for more information.

(All standalone, DMX address and configuration settings are non-volatile, meaning they will not change if power is lost or switched off and restored. When set to manual mode, the Miro Cube operates as a DMX Master and is sending DMX512 data.)



## Manual Mode

### Miro Cube 4C & 4CA

Manual Mode allows you to set the color of your fixture by adjusting the intensity of the LEDs using the rear panel and the LCD display. The current value of each setting is shown on the main screen.

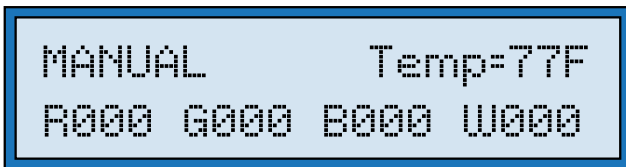

To adjust color values, press the **MENU** key until the desired color is listed on the LCD screen. Press **OK**. Use the **▲** or **▼** keys to select a value between **“0”** and **“255”**. Then press **OK**. Press **MENU** to select the next color.



## Manual Mode

### Miro Cube WNC/3W

When set to Manual Mode, the WNC allows you to set the color of your fixture by adjusting the temperature of the LEDs using the rear panel and the LCD display. The current value of each setting is shown on the main screen.

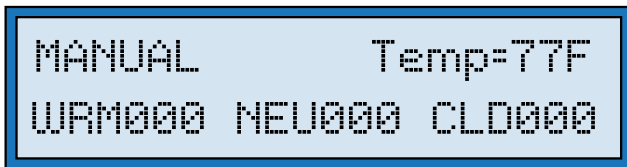

To adjust color values, press the **MENU** key until the desired color is listed on the LCD screen. Press **OK**. Use the ▲ or ▼ keys to select a value between “0” and “255”. Then press **OK**. Press **MENU** to select the next color.

#### Color Temperature:

WRM = 2700K

NEU = 4000K

CLD = 6500K



## Manual Mode

### Miro Cube UV365

Manual Mode can be used to adjust the brightness of a Miro Cube UV365. The current brightness level is shown on the main screen.

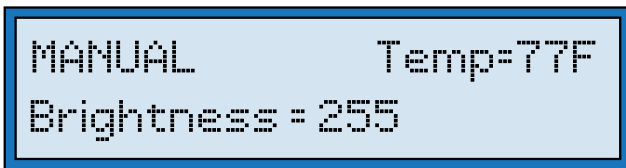

To adjust color value, press the **MENU** key until **“CHANGE BRIGHTNESS”** appears on the LCD screen. Press OK. Use the ▲ or ▼ keys to select a value between **“0”** and **“255”**. Then press OK.



## Color Wash Mode

Color wash is only available in Miro Cube 4C & 4CA. In Color Wash mode, the Miro Cube automatically cycles through its entire saturated color spectrum by modulating the intensity of the red, green, and blue LEDs.



There are two user settings that can be adjusted in Color Wash mode. The current value of each setting is shown on the main screen.





## Color Wash Mode

### Wash Timer

The wash timer determines how long it takes for the Miro Cube to complete an entire color cycle, and, by extension, the rate at which the colors change. Choose a short time for a rapid wash or a longer time for a slower wash. To change the Wash Timer, press **MENU** and select **“CHANGE WASH TIMER?”** by pressing **OK**. Use the **▲** or **▼** keys to select a Wash Time between 15 seconds and 60 minutes (in 15 second intervals).

### Wash Offset:

When set to Color Wash Mode, the Miro Cube is operating as a DMX master and is sending DMX512 data, allowing it to control unique color washes on up to fourteen additional fixtures in a chain (set to DMX mode).

**NOTE:** Slave fixtures should be set to DMX Mode and assigned to channels five, nine, thirteen, etc (in four channel increments).

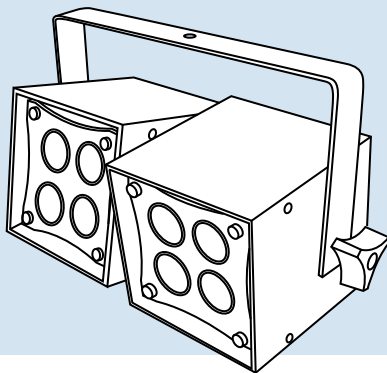

Use the WASH OFFSET function to control the interaction between multiple Miro Cubes in a Color Wash chain. The Wash Offset determines the length of delay between each light, or how long it takes to “pass” a color from one light to the next. Set the Wash Offset to “0” and the lights will color wash in unison, displaying the same color at the same time. Create a multi-fixture Chasing Rainbow effect, where colors pass from light to light, by increasing the Wash Offset. The larger the offset time, the longer it takes for a color to pass to the next light.

To change the Wash Offset, press **MENU** and select **“CHANGE WASH OFFSET?”** by pressing **OK**. Use the **▲** or **▼** keys to select the time delay (up to 511 seconds) between lights.



## Serial Mode

In Serial mode, the unit is controlled by the serial data it receives on the XLR connector located on the rear panel or via CubeConnect®. If your unit does not have Serial Mode you will need to enable it by entering **FACTORY SETUP** using the **MENU** button. For the password enter “**3270**”. Using the **MENU** button to toggle through the options select **SET CONFIG OPTIONS** and click **OK**. Next use the **MENU** button to toggle through the options select **SERIAL MODE ON** and click **OK**. Finally click **OK** to exit.

The serial address required to control the fixture is dependent on the factory setting in use (for example - four color Miro Cubes use four Serial Channels while one color Miro Cubes use one).

### Serial Address

To change the Serial address, press **MENU** until “**CHANGE SER ADDRESS?**” appears on the LCD, and press **OK**. Select the desired Serial address using the ▲ or ▼ keys, and press **OK**.



## Beam Angles

The beam angle can be easily adjusted using a spread lens. Using a Miro Cube without a spread lens will create a 12° beam angle.

**WARNING:** DISCONNECT THE POWER CABLE BEFORE REMOVING THUMBSCREWS.

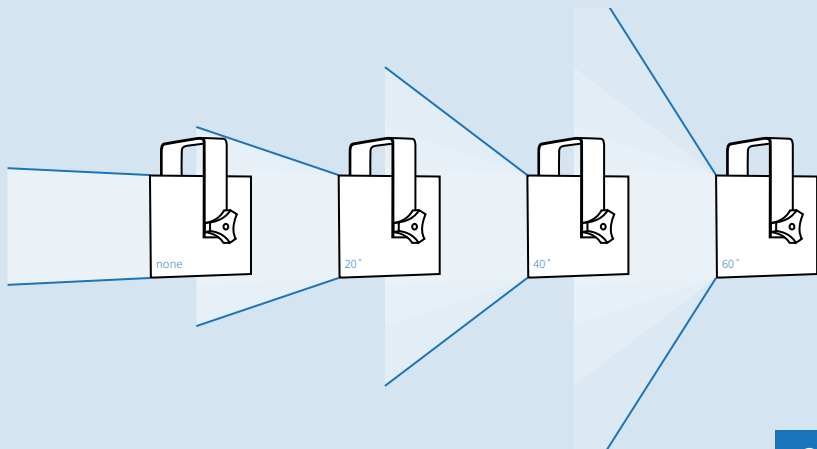



## Beam Angles

To change the spread lens, unscrew the thumbscrews from the front panel and remove the acrylic panel. Replace the existing spread lens with the lens of your choice. Place the acrylic panel on top and secure it with four thumbscrews.

**NOTE:** Custom spread lenses are available upon request.

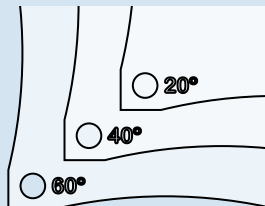
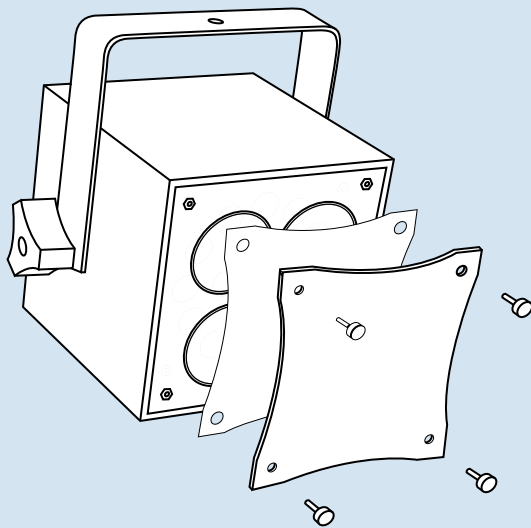



## Mounting

**WARNING:** DISCONNECT THE POWER CABLE BEFORE MAKING ANY CONFIGURATION ADJUSTMENTS.

### Linear Arrays:

The Miro Cube can be used as a single fixture or in multi-fixture arrays.

**NOTE:** ADDITIONAL YOKES AND THREADED ROD ARE REQUIRED.

To connect multiple fixtures, remove the threaded rod by unscrewing one of the side knobs and using the other to pull the rod out. Slide off the yoke and washers and put them to the side.

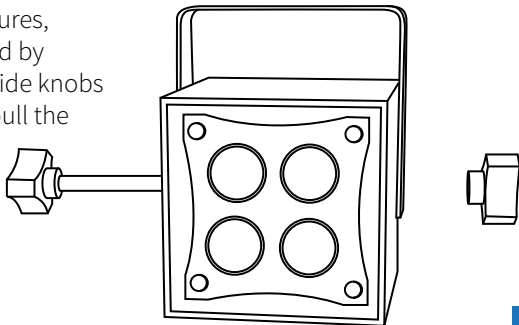

Place the fixtures next to each other. Attach a knob to one side of the double length threaded rod. Slide the double bracket around the fixtures. Align the holes and position spacers on both sides of each fixture (do not use multiple spacers between fixtures).

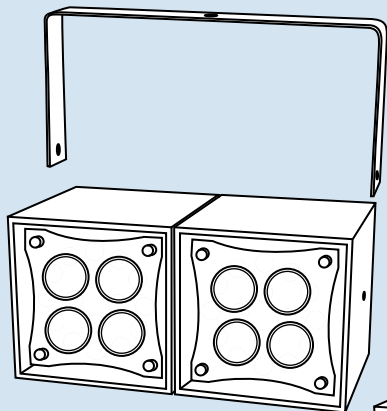

Insert the rod on the left side. Slide the rod through the bracket and both fixtures and secure it with a knob on the right side.

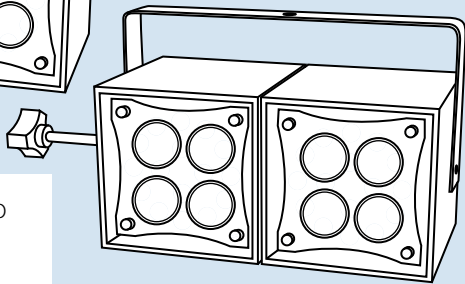

A maximum of three Miro Cubes can be arrayed linearly using provided hanging brackets.



## Safety Cables

Single Miro Cubes as well as arrays can be suspended from truss or other major support structures using 3rd party clamping devices. When used in suspended applications, a safety cable (provided by others) is recommended as a positive retaining means between the main support structure and each Miro Cube using the “safety cable hole.”

**NOTE:** The cable can be threaded through, or clip can be snapped directly onto the safety cable hole.

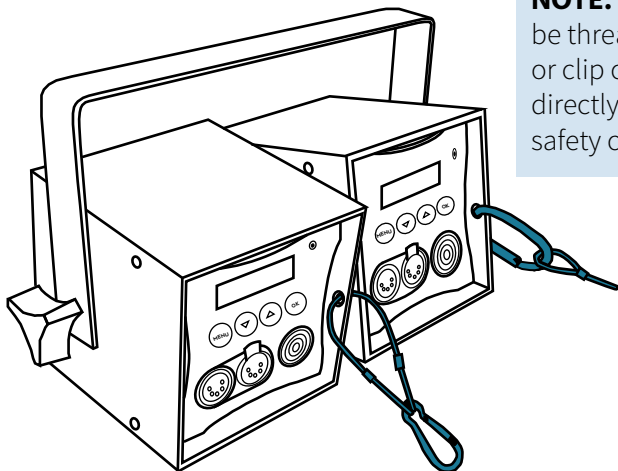





## FCC Warning

**This equipment has been tested and found to comply with the regulations for a Class A digital device, pursuant to Part 15 of the FCC Rules. These limits are designed to provide reasonable protection against harmful interference when the equipment is operated in a commercial environment. This equipment generates, uses, and can radiate radio frequency energy and, if not installed and used in accordance with this user's guide, may cause harmful interference to radio communications. Operation of this equipment in a residential area is likely to cause harmful interference, in which case the user will be required to correct the interference at his own expense.**



## General Precautions

1. The use of a safety cable is recommended when rigging the fixture.
2. Before use, make sure all screws and safety points are secured.
3. Make sure the light is unplugged before performing any service to the unit.
4. **ALWAYS** keep this product out of reach of children and untrained persons.
5. **ALWAYS** adhere to safety instructions and warnings, including any and all instructions set forth in the Product Specifications.
6. To allow for proper cooling, airflow must not be restricted through the front and rear of the fixture - do not block off the front or rear panel.
7. For Dry locations/Indoor use only.



## Warning Messages

The Miro Cube has warning messages built in that will instruct you when an action needs to be taken. On startup, if a DMX signal is not present on the DMX connectors, and the fixture is set to DMX mode, all of the LEDs will glow dimly. This feature can be used for troubleshooting your DMX control lines. Once DMX is detected the fixture will instantaneously respond to the command it is given. The Miro Cube is equipped with an internal temperature sensor. If an overheat condition is experienced all of the red LEDs will glow dimly and a warning message will be displayed on the rear LCD. If this occurs unplug the power connector from the unit and wait three seconds. Plug the fixture in again. If the same condition occurs again contact the manufacturer.



Notes



Notes



Notes



**ROSCO**

W W W . R O S C O . C O M

**MIRO CUBE®**

DESIGNED BY THE BLACK TANK